

# ZECCHINON



KITCHEN / COLLECTION

TIMELESS MOODS

100%  
MADE  
IN  
ITALY

# Kitchen collection

Timeless moods

**ZECCHINON**

# Contents

**04.** A family company

**06.** Collezione Frame

**10.** Frame 1.5

**44.** Frame 5.0

**10.** Parigi

**24.** Salento

**44.** San Diego

**60.** Londra

**80.** Cotswolds

**96.** Brooklyn

**110.** Bordeaux

## A family company

### The strenght of a family tradition looking to the future.

Since 1948, three generations have shaped kitchens designed to last and evolve, a true expression of excellence and timeless beauty, inspired by the spirit of Made in Italy.

### La forza di una tradizione familiare che guarda al futuro.

Da 1948, tre generazioni danno forma a cucine pensate per durare ed evolversi. Una vera espressione dell'eccellenza e della bellezza senza tempo del Made in Italy.

FR\_La force d'une tradition familiale tournée vers l'avenir.  
Depuis 1948, trois générations façonnent des cuisines conçues pour durer et évoluer, véritable expression de l'excellence et de la beauté intemporelle du Made in Italy.

Since 1949



# Frame 1.5 / Frame 5.0

**Massima libertà, massima coerenza.**

Ritmo colore e natura si incontrano nelle collezioni cucina Frame. Spazi che si adattano al vivere contemporaneo, mantenendo intatta l'armonia del design italiano e un gusto autenticamente internazionale.

EN\_ **Frame. Maximum freedom, maximum consistency.** Colour, rhythm and nature come together in the Frame kitchen collections. Spaces that adapt to contemporary living while preserving the harmony of Italian design and an authentically international appeal.

FR\_ **Frame. Liberté maximale, cohérence maximale.** Couleur, rythme et nature se rencontrent dans les collections de cuisines Frame. Des espaces qui s'adaptent à la vie contemporaine, tout en conservant l'harmonie du design italien et une esthétique authentiquement internationale.

## FRAME 1.5

Si presenta come una celebrazione dell'equilibrio formale, dove ogni dettaglio parla di ordine e precisione. Una cornice perimetrale sottile, di appena 14 mm, contorna con discrezione ma decisione l'intera struttura, conferendo un senso di rigore e armonia visiva.

### Finiture

Finishes/Finitions

Essenze: 5 essenze Rovere,  
1 essenza Termocotto e 3 essenze  
Castagno  
EN\_ Veneers: 5 Oak veneers, 1 Hot  
treated oak veneers and 3 Chestnut  
veneers  
FR\_ Placage Bois: 5 placage bois  
Chêne, 1 placage bois Chené  
Termocotto e 3 placage bois  
Chataignier

Colore: 25 laccati opachi  
EN\_ Color finishes: 25 mat lacquered  
FR\_ Color finitions: 25 laqué mat



### Sistemi di apertura

Système d'ouverture/Opening system

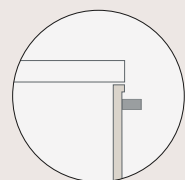

Maniglia  
Handle  
Poignée

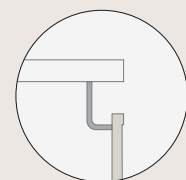

Gola Systemkappa  
Systemkappa Groove  
Gorge Systemkappa

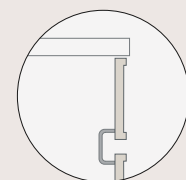

Gola intermedia  
Middle Groove  
Gorge intermédiaire

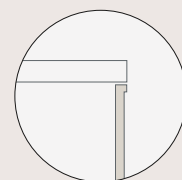

Push-pull  
Push-pull handle  
Push-pull



EN\_ **FRAME 1.5** is a celebration of formal balance, where every detail speaks of order and precision. A thin perimeter frame, just 14 mm wide, discreetly yet decisively outlines the entire structure, conveying a sense of rigor and visual harmony.

FR\_ **FRAME 1.5** se présente comme une célébration de l'équilibre formel, où chaque détail évoque l'ordre et la précision. Un cadre périphérique fin, d'à peine 14 mm, entoure avec discrétion mais détermination l'ensemble de la structure, conférant un sentiment de rigueur et d'harmonie visuelle.

**Paris . where every street tells a story,  
every light becomes emotion, and timeless  
charm meets modernity.**

## FRAME 1.5

**Finiture:**

Laccato opaco Camelia  
Laccato opaco Anfora  
Dekton Nebbia

**Finishes:**

Matt lacquered Camelia  
Matt lacquered Anfora  
Dekton Nebbia

**Finitions:**

Laqué mat Camelia  
Laqué mat Anfora  
Dekton Nebbia

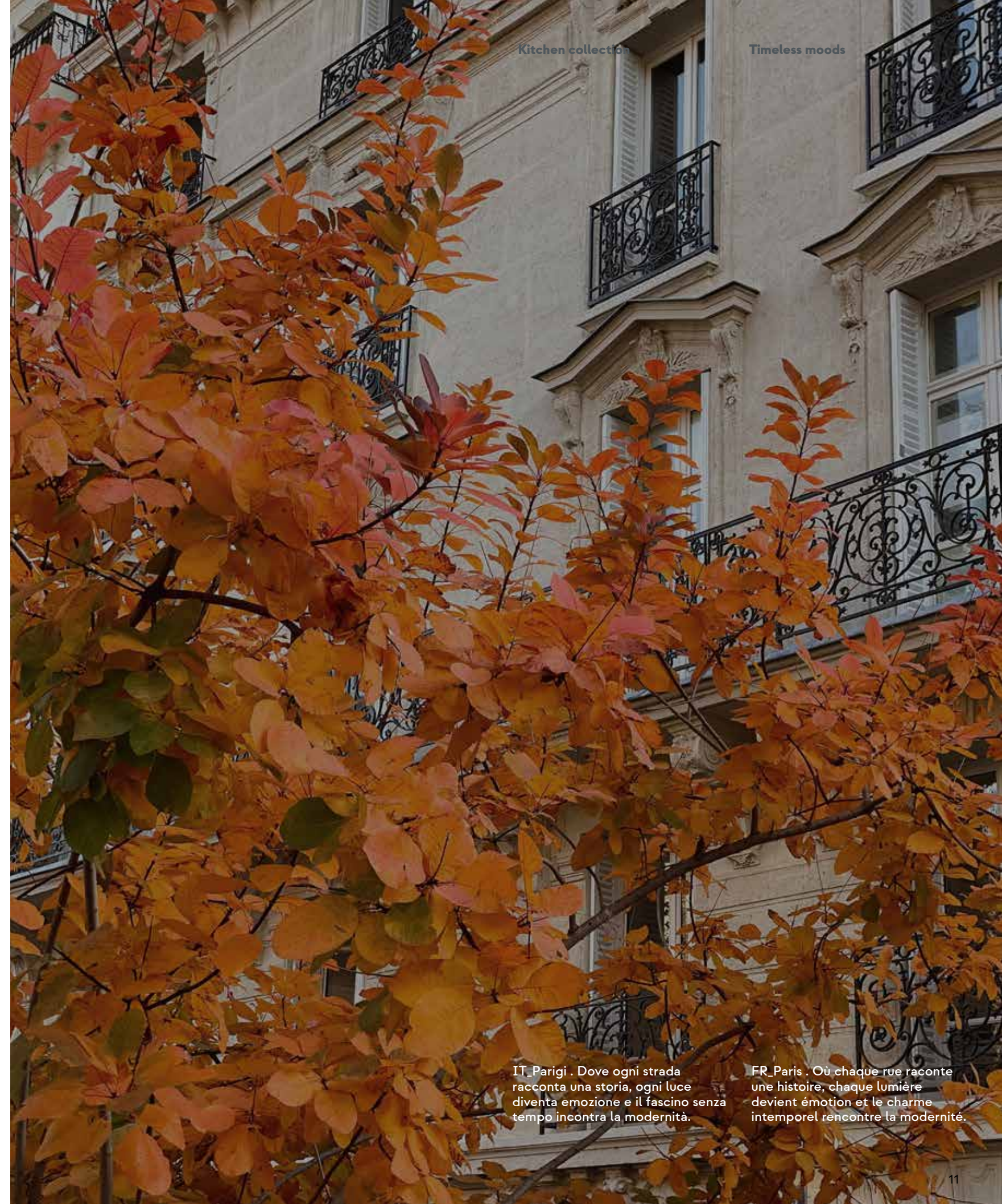
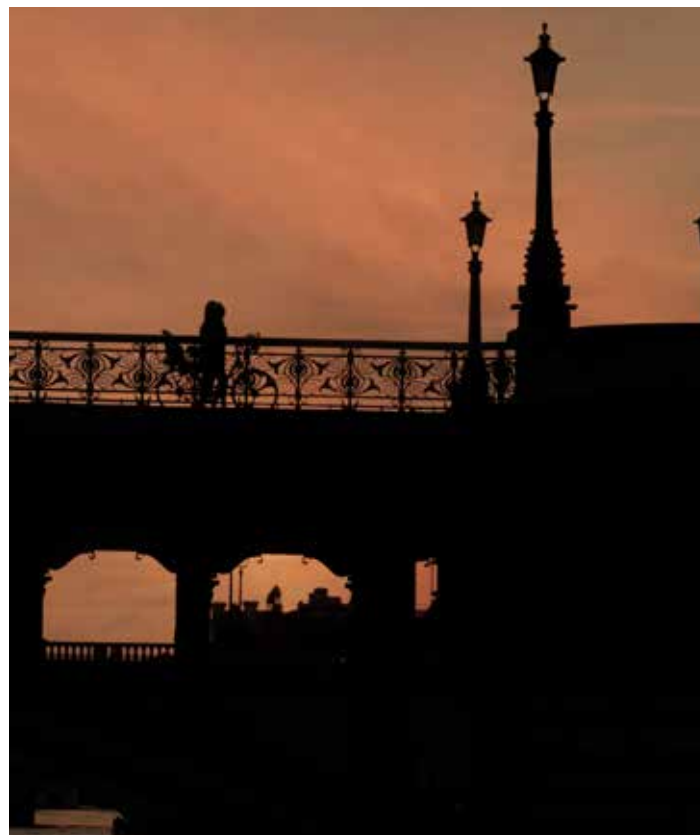

IT Parigi . Dove ogni strada  
racconta una storia, ogni luce  
diventa emozione e il fascino senza  
tempo incontra la modernità.

FR Paris . Où chaque rue raconte  
une histoire, chaque lumière  
devient émotion et le charme  
intemporel rencontre la modernité.







Finishes/Finitions  
Laccato opaco Camelia  
Laccato opaco Anfora  
Dekton Nebbia



## FRAME 1.5

Un rifugio parigino intriso di charme, modellato dal rigore e dalla bellezza senza tempo del design italiano.

EN\_ A Parisian retreat infused with charm, shaped by the timeless beauty and refined rigor of Italian design.

FR\_Un refuge parisien empreint de charme, façonné par la rigueur et la beauté intemporelle du design italien.



**Finishes/Finitions**  
Laccato opaco Camelia  
Laccato opaco Anfora  
Dekton Nebbia





Finishes/Finitions  
Laccato opaco Camelia  
Laccato opaco Anfora  
Dekton Nebbia



**Salento . among ancient olive trees and golden shores, places that embody a vibrant and authentic identity.**

## FRAME 1.5

**Finiture:**

Laccato opaco Ghiatia  
Rovere Ghianda  
Dekton Reverie

**Finishes:**

Matt lacquered Ghiatia  
Oak Ghianda  
Dekton Reverie

**Finitions:**

Laqué mat Ghiatia  
Chêne Ghianda  
Dekton Reverie



IT\_Salento . Tra ulivi secolari e rive dorate, luoghi che raccontano un'identità vibrante e autentica.

FR\_Salento . Entre oliviers centenaires et rivages dorés, des lieux qui racontent une identité vibrante et authentique.





Finishes/Finitions  
Laccato opaco Ghiaia  
Rovere Ghianda  
Dekton Reverie





## FRAME 1.5

Una calda atmosfera di luci soffuse e ulivi accende la cucina con un tocco mediterraneo di eleganza e serenità.

EN\_ A warm atmosphere of soft lighting and olive trees illuminates the kitchen with a Mediterranean touch of elegance and serenity.

FR\_ Une atmosphère chaleureuse créée par des lumières tamisées et des oliviers illumine la cuisine d'une touche méditerranéenne d'élégance et de sérénité.





Finishes/Finitions  
Laccato opaco Ghiaia  
Rovere Ghianda  
Dekton Reverie

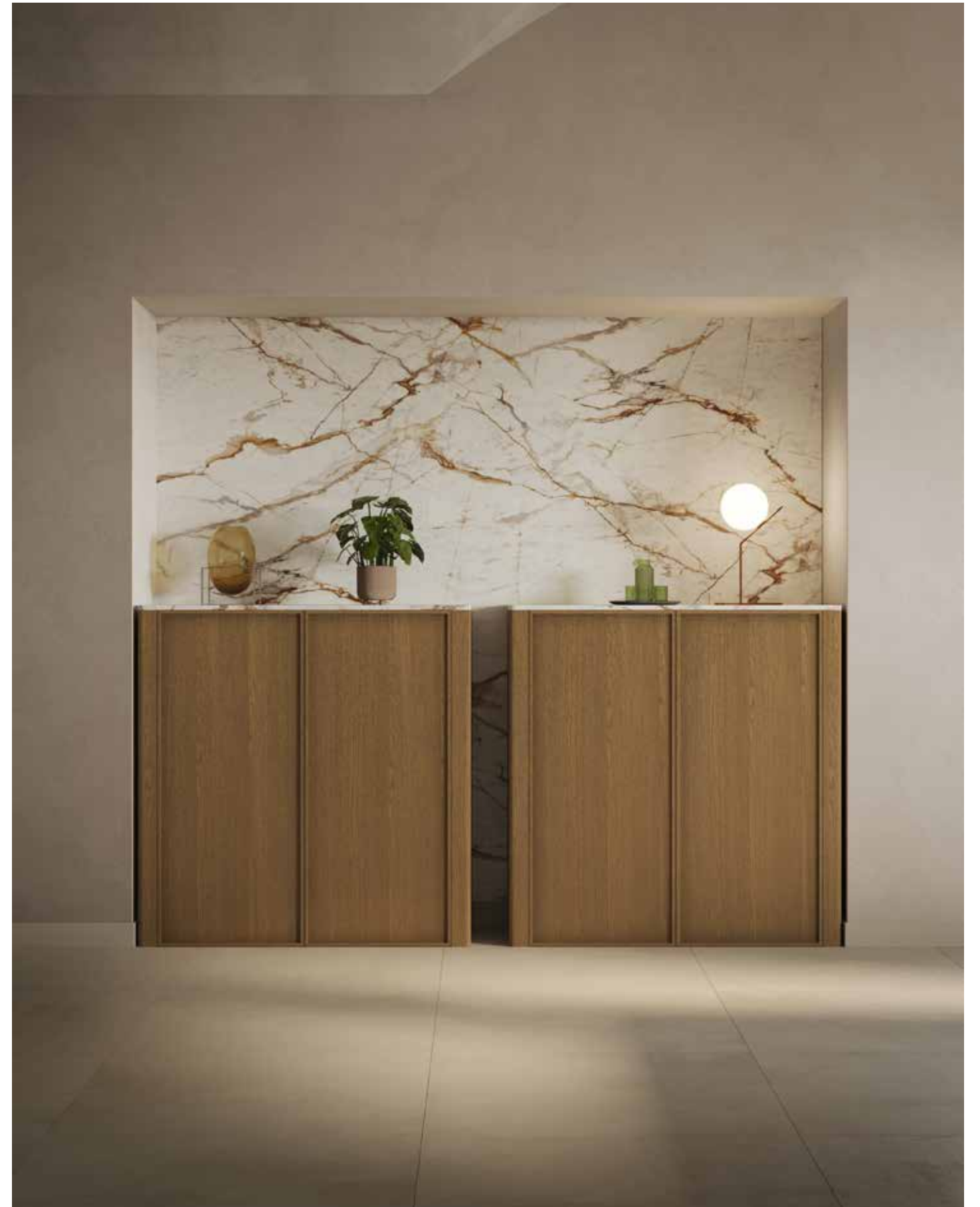

# FRAME 5.0

Esprime una visione solida e attuale: un'anta con telaio da 50 mm che conferisce alla cucina un carattere deciso, un perfetto equilibrio geometrico e uno stile contemporaneo.

## Finiture

Finishes/Finitions

Essenze: 5 essenze Rovere,  
3 essenze Castagno  
EN\_ Veneers: 5 Oak veneers, 3  
Chestnut veneers  
FR\_ Placage Bois: 5 placage bois  
Chêne, 3 placage bois Chataignier

Colore: 25 laccati opachi  
EN\_ Color finishes: 25 mat lacquered  
FR\_ Color finitions: 25 laqué mat



## Sistemi di apertura

Système d'ouverture/Opening system

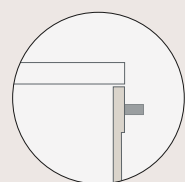

Maniglia  
Handle  
Poignée

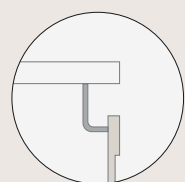

Gola Systemkappa  
Systemkappa Groove  
Gorge Systemkappa

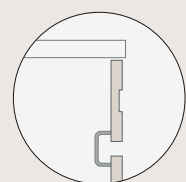

Gola intermedia  
Middle Groove  
Gorge intermédiaire

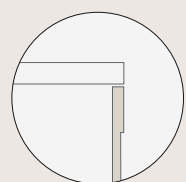

Push-pull  
Push-pull handle  
Push-pull

EN\_ FRAME 5.0 embodies a solid, modern vision: a 50 mm frame door that gives the kitchen a bold character, perfect geometric balance, and a contemporary style.

FR\_ FRAME 5.0 exprime une vision solide et actuelle : une porte avec un cadre de 50 mm qui confère à la cuisine un caractère affirmé, un équilibre géométrique parfait et un style contemporain.

# FW05

Le vetrine con cornici contemporanee disegnano geometrie leggere, combinando trasparenza e linee pulite in un'eleganza che fonde passato e presente.

EN\_ FW05, display cabinets with contemporary frames create light geometric shapes, combining transparency and clean lines in an elegant style that blends past and present.

FR\_ FW05, les vitrines aux cadres contemporains dessinent des géométries légères, alliant transparence et lignes épurées dans une élégance qui fusionne passé et présent.



Vetro  
cannettato  
satinato

EN\_ Fluted etched glass  
FR\_Verre acide rainuré

Vetro bronzato  
trasparente

EN\_Bronzed transparent glass  
FR\_Verre bronzé transparent

Vetro trasparente

EN\_Transparent glass  
FR\_Verre transparent

**San Diego** . between a sparkling ocean and endless skies, the light of California reflects a relaxed, contemporary style.

## FRAME 5.0

**Finiture:**

Laccato opaco Camelia  
Larice Arctic  
Quarzite Cosmopolitan

**Finishes:**

Matt lacquered Camelia  
Larch Arctic  
Quarzite Cosmopolitan

**Finitions:**

Laqué mat Camelia  
Mélèze Arctic  
Quarzite Cosmopolitan



IT\_San Diego . Tra oceano scintillante e cieli infiniti, la luce della California si riflette in uno stile rilassato e contemporaneo.

FR\_San Diego . Entre océan scintillant et ciel infini, la lumière californienne se reflète dans un style décontracté et contemporain.





## FRAME 5.0

Un lussuoso lavello in quarzite scolpisce la cucina con la sua eleganza materica, unendo raffinatezza naturale e funzionalità in una villa dal carattere esclusivo a San Diego.

EN\_A luxurious quartzite sink sculpts the kitchen with its material elegance, combining natural refinement and functionality in an exclusive villa in San Diego.

FR\_Un évier luxueux en quartzite sculpte la cuisine avec son élégance matérielle, alliant raffinement naturel et fonctionnalité dans une villa exclusive à San Diego.





Finishes/Finitions  
Laccato opaco Camelia  
Larice Arctic  
Quarzite Cosmopolitan





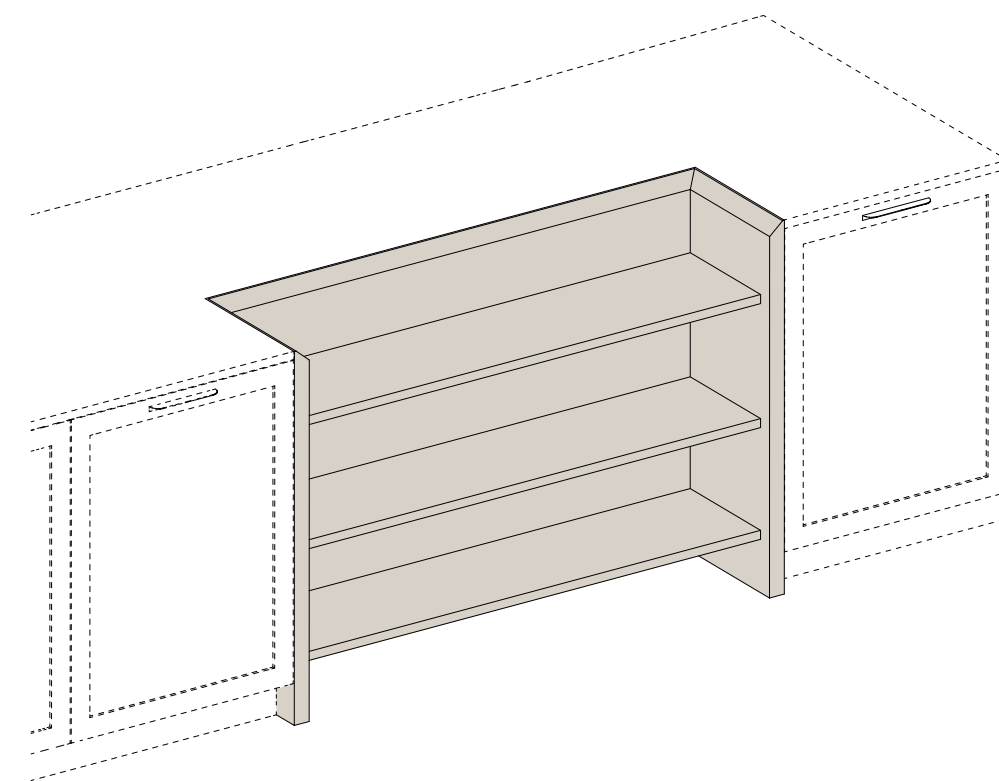

## Libreria COTTAGE

Cottage, la libreria dalle proporzioni leggere e raffinate, progettata per integrarsi con naturalezza tra le basi cucina e dare vita a un equilibrio armonioso tra contenimento, estetica e leggerezza formale.

EN\_Cottage, a bookcase with light and elegant proportions, conceived to integrate seamlessly between the kitchen bases, achieving a harmonious balance of storage, aesthetics, and formal lightness.

FR\_Cottage, la bibliothèque aux proportions légères et raffinées, conçue pour s'intégrer naturellement entre les éléments bas de la cuisine et créer un équilibre harmonieux entre rangement, esthétique et légèreté formelle.

**London . the city where the past illuminates  
the style of the present with distinctive elements.**

## FRAME 5.0

**Finiture:**

Laccato opaco Gianduia  
Plissé Gianduia  
Quarzite Taj

**Finishes:**

Matt lacquered Gianduia  
Pleated Gianduia  
Quarzite Taj  
**Finitions:**  
Laqué mat Gianduia  
Plissé Gianduia  
Quarzite Taj

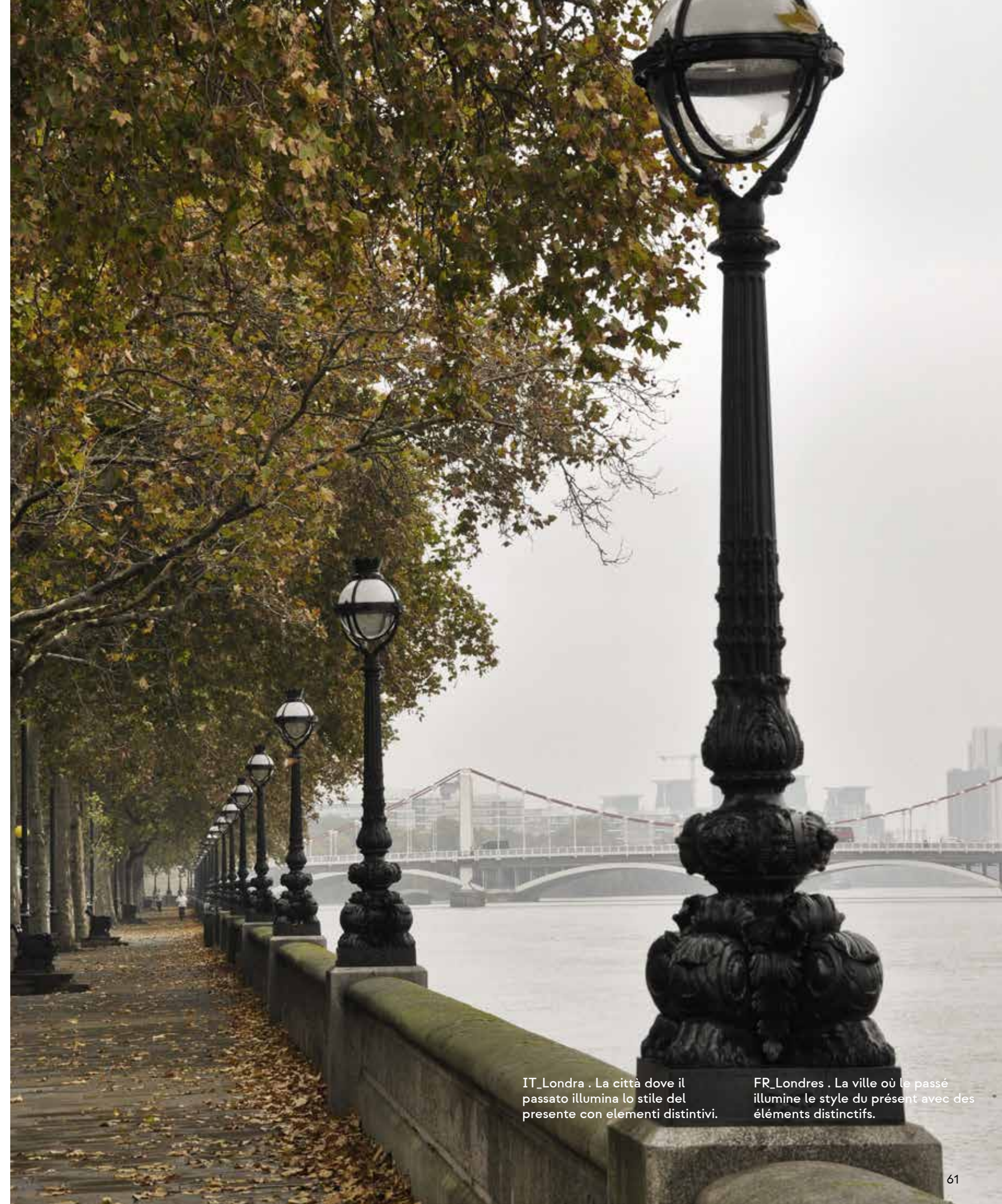

IT\_Londra . La città dove il  
passato illumina lo stile del  
presente con elementi distintivi.

FR\_Londres . La ville où le passé  
illumine le style du présent avec des  
éléments distinctifs.







## FRAME 5.0

La lavorazione plissé laccata e le ante con telaio danno vita a un insieme di carattere e personalità, dove materia e dettaglio definiscono uno stile deciso e distintivo.

EN\_ The lacquered pleated finish and framed doors create a look full of character and personality, where materials and details define a bold and distinctive style.

FR\_Le travail plissé laqué et les portes à cadre créent un ensemble plein de caractère et de personnalité, où les matériaux et les détails définissent un style affirmé et distinctif.



Finishes/Finitions  
Laccato opaco Gianduia  
Plissé Gianduia  
Quarzite Taj



Il worktop in Taj, con le sue delicate sfumature avorio e le venature dorate tracciate come pennellate, infonde alla cucina una bellezza eterea, resistente e sofisticata.

EN\_The Taj worktop, with its delicate ivory shades and golden veins traced like brushstrokes, infuses the kitchen with an ethereal, durable and sophisticated beauty.

FR\_Le plan de travail Taj, avec ses délicates nuances ivoire et ses veines dorées tracées comme des coups de pinceau, confère à la cuisine une beauté éthérée, résistante et sophistiquée.





Finishes/Finitions  
Laccato opaco Gianduia  
Plissé Gianduia  
Quarzite Taj



## REVEGO

L'innovativo sistema Revego permette la chiusura degli spazi operativi quando non sono in uso in modo semplice e intuitivo. L'assenza di maniglia crea una gradevole pulizia di stile. Una soluzione meccanica che offre un confort di movimento molto elevato sia in apertura che in chiusura.

EN\_The innovative Revego system allows the closure of operating spaces when they are not in use in a simple and intuitive way. The absence of a handle creates a pleasant, clean style. A mechanical solution that offers a very high comfort of movement both in opening and closing.

FR\_Le système innovant Revego permet de fermer de manière simple et intuitive les espaces de travail lorsqu'ils ne sont pas utilisés. L'absence de poignée crée un style agréable et épuré. Une solution mécanique qui offre un très haut niveau de confort de mouvement tant à l'ouverture qu'à la fermeture.



# Cotswolds . among gentle hills and golden stone villages, the authentic charm of the English countryside.

## FRAME 1.5

### Finiture:

Laccato opaco Cashmere  
Laccato opaco Alloro  
Rovere Castoro  
Ceramica Calacatta Imperiale

### Finishes:

Matt lacquered Cashmere  
Matt lacquered Alloro  
Oak Castoro  
Ceramica Calacatta Imperiale

### Finitions:

Laqué mat Cashmere  
Laqué mat Alloro  
Chêne Castoro  
Ceramica Calacatta Imperiale



IT\_Cotswolds . Tra colline morbide e villaggi di pietra dorata, il fascino autentico della verde campagna inglese prende vita.

FR\_Cotswolds . Entre collines vallonnées et villages aux pierres dorées, le charme authentique de la campagne verdoyante anglaise prend vie.







Finishes/Finitions:  
Laccato opaco Cashmere  
Laccato opaco Alloro  
Rovere Castoro  
Ceramica calacatta imperiale



## FRAME 5.0

Entrando in cucina, si respira l'atmosfera di un giardino inglese: profumi delicati, dettagli rustici e un'eleganza naturale senza tempo.

EN\_Upon entering the kitchen, one is enveloped in the atmosphere of an English garden: delicate scents, rustic details, and timeless natural elegance.

FR\_En entrant dans la cuisine, on est immédiatement plongé dans l'atmosphère d'un jardin anglais : parfums délicats, détails rustiques et élégance naturelle intemporelle.





Finishes/Finitions:  
Laccato opaco Cashmere  
Laccato opaco Alloro  
Rovere Castoro  
Ceramica calacatta imperiale



**Finishes/Finitions:**  
Laccato opaco Cashmere  
Laccato opaco Alloro  
Rovere Castoro  
Ceramica calacatta imperiale



**Brooklyn** . in the green heart of Brooklyn,  
among century-old trees, blooming avenues, and  
historic homes, kitchens come to life with refined  
design and a welcoming soul.

## FRAME 5.0

**Finiture:**

Laccato opaco Camelia  
Marmo Breccia Sarda

**Finishes:**

Matt lacquered Camelia  
Marble Breccia Sarda

**Finitions:**

Laqué mat Camelia  
Marbre Breccia Sarda



IT\_Brooklyn . Nel cuore verde di  
Brooklyn, tra alberi secolari, viali  
fioriti e case storiche, prendono  
vita cucine dal design raffinato e  
dall'anima accogliente, rilassata e  
contemporanea.

FR\_Brooklyn . Au cœur verdoyant de  
Brooklyn, entre arbres centenaires,  
avenues leurries et maisons  
historiques, des cuisines au design  
rafiné et à l'âme accueillante  
prennent vie.





Finishes/Finitions:  
Laccato opaco Camelia  
Marmo Breccia Sarda



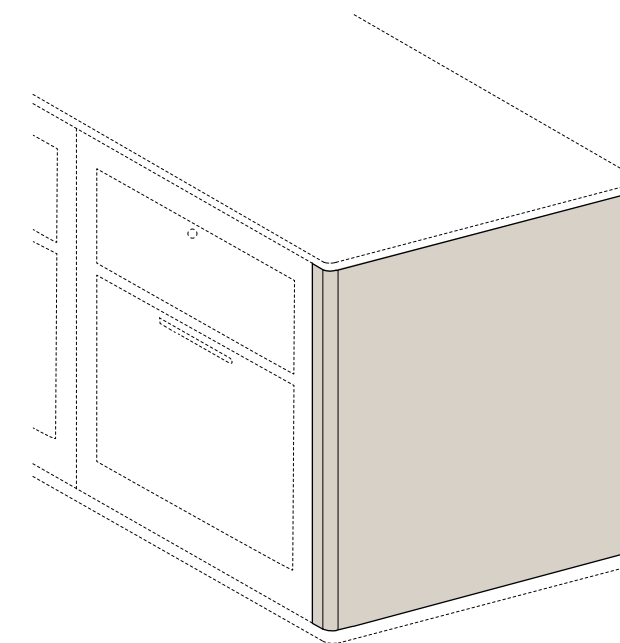

## Curve morbide, volumi che accolgono.

Linee fluide e terminali arrotondati ridisegnano lo spazio cucina con eleganza. Funzionalità e bellezza si uniscono in un design armonioso, fatto di materiali autentici e atmosfere accoglienti.

**EN\_Soft curves, welcoming volumes.** Fluid lines and rounded edges redefine the kitchen space with elegance. Functionality and beauty come together in a harmonious design, made of authentic materials and inviting atmospheres.

**FR\_Des courbes douces, des volumes accueillants.** Des lignes fluides et des extrémités arrondies redessinent avec élégance l'espace cuisine. Fonctionnalité et beauté s'unissent dans un design harmonieux, fait de matériaux authentiques et d'atmosphères accueillantes.



Finishes/Finitions:  
Laccato opaco Camelia  
Marmo Breccia Sarda



Il piano di lavoro in Breccia Sarda, prezioso marmo italiano, racconta la forza della pietra e la delicatezza delle sue venature, dove eleganza, armonia e funzionalità si fondono in un'unica espressione di stile raffinato e naturale.

EN\_The worktop in Breccia Sarda, a prized Italian marble, showcases the strength of the stone and the delicacy of its veins, where elegance, harmony and functionality come together in a single refined and natural style.

FR\_Le plan de travail en Breccia Sarda, un marbre italien précieux, témoigne de la force de la pierre et de la délicatesse de ses veines, où élégance, harmonie et fonctionnalité se fondent en une seule expression de style raffiné et naturel.



**Bordeaux**. where the countryside unfolds like a slow breath and design finds a new harmony, shaped by essential lines, materiality, and atmospheres.

## FRAME 5.0

**Finiture:**

Rovere Ghianda  
Rovere Ghianda plissé  
Ceramica Blanco Arenado

**Finishes:**

Oak Ghianda  
Oak Ghianda Plissé  
Ceramica Blanco arenado

**Finitions:**

Chêne Ghianda  
Chêne Ghianda Plissé  
Ceramica Blanco Arenado



IT\_Bordeaux . Dove le campagne si distendono come un respiro lento e il design trova una nuova armonia, fatta di linee essenziali, matericità e atmosfere.

FR\_Bordeaux . Où la campagne s'étire comme un souffle lent et où le design trouve une nouvelle harmonie, faite de lignes essentielles, de matérialité et d'atmosphères.





## FRAME 5.0

Ispirata alla quiete della campagna di Bordeaux, una cucina che interpreta atmosfere luminose e autentiche.

EN\_Inspired by the tranquility of the Bordeaux countryside, a kitchen that evokes luminous and authentic atmospheres.

FR\_Inspirée par le calme de la campagne bordelaise, une cuisine qui interprète des atmosphères lumineuses et authentiques.





Finishes/Finitions:  
Rovere Ghianda  
Rovere Ghianda Plissé  
Ceramica Blanco Arenado







## FRAME 5.0

Il fianco curvo e le ante in rovere plissé conferiscono alla composizione un autentico senso di charme.

EN\_The curved side panel and the pleated oak doors give the composition an authentic sense of charm.

FR\_Le flanc courbe et les portes en chêne plissé confèrent à la composition un authentique sens du charme.







Zecchinon è presente in tanti paesi del mondo, oltre a una distribuzione consolidata sul territorio italiano, si aggiunge un network internazionale in continua crescita che comprende circa 300 negozi nel mondo. All'interno di questa rete si aggiungono i negozi monomarca che rappresentano nel mondo la filosofia Zecchinon.

The company is now present in many countries around the world, in addition to the consolidated distribution in Italy, we created an international network of about 300 shops around the world, which is continuously growing. This network also includes flagship stores that represent the Zecchinon philosophy in the world.

Zecchinon est présent dans plusieurs pays dans le monde, outre à une distribution consolidée sur le territoire italien, on ajoute un réseau international qui continue d'augmenter et qui comprend 300 magasins dans le monde. À l'intérieur de ce réseau on ajoute les magasins mono-marque qui représentent dans le monde la philosophie Zecchinon.

ZECCHINON CUCINE si riserva il diritto di apportare, senza preavviso, ogni modifica mirata al miglioramento funzionale e qualitativo dei propri prodotti. Testi e disegni presenti in questo stampato hanno scopo divulgativo: per ogni aspetto tecnico e dimensionale fare riferimento ai listini aziendali e relativi aggiornamenti. I campioni di colori e materiali hanno valore indicativo.

PER AGGIORNAMENTI RELATIVI ALLE FINITURE CONSULTATE SEMPRE IL NOSTRO SITO [WWW.ZECCHINON.IT](http://WWW.ZECCHINON.IT)

ZECCHINON CUCINE reserves the right to make without notice any changes aimed at improving the functions and qualities of its products. The texts and drawings in this publication are purely for advertising purposes: for technical and dimensional aspects consult the company price lists and updates. Colour and material samples are indicative.

FOR UPDATES ON MATERIALS AND FINISHES, ALWAYS VISIT OUR WEBSITE [WWW.ZECCHINON.IT](http://WWW.ZECCHINON.IT)

ZECCHINON CUCINE se réserve le droit d'apporter, sans préavis, toute modification destinée à l'amélioration fonctionnelle et qualitative de ses produits. Les textes et les dessins présents dans cet imprimé sont divulgués à titre informatif: pour tout aspect technique et de dimension, se référer aux listes d'entreprise et leurs mises à jour correspondantes. Les échantillons de couleur et les matériaux ont une valeur indicative.

POUR DES MISES A JOUR CONCERNANT DES MATERIAUX ET DES FINITIONS CONSULTEZ TOUJOURS NOTRE SITE [WWW.ZECCHINON.IT](http://WWW.ZECCHINON.IT)

Design  
Zecchinon R&D + Haften Studio

Art Direction and Graphics  
Haften Studio

Virtual images  
Neiko

Print  
Grafiche Italprint

ZECCHINON CUCINE srl  
Via Castello, 133  
31020 - Sernaglia della Battaglia (TV)  
ITALIA  
tel +39 0438 860341  
[www.zecchinon.it](http://www.zecchinon.it)



**100%**  
**MADE**  
**IN**  
**ITALY**

ZECCHINON  
since 1949

[zecchinon.it](http://zecchinon.it)